

	Standard Fastener	Heavy Duty Fastener	XHD® Fastener	#12 ASAP® with Steel Plate	#12 ASAP® with Plastic Plate	Masonry Anchor
						
THREAD DIA./STYLE	#12 / modified buttress	#14 / AB symmetrical thread	#15 / modified buttress, mini drill point	#12 / modified buttress	#12 / modified buttress	Zinc alloy with zinc-plated steel pin
DECK TYPES	18 – 24 ga. steel, wood	18 – 22 ga. steel, wood, concrete (3/16" pilot hole)	18 – 24 ga. steel, wood	18 – 24 ga. steel, wood	18 – 24 ga. steel, wood	Concrete
FOR USE WITH	3" Insulation Plate	3" Insulation Plate, 2" Seam Plate	3" Insulation Plate, 2" Seam Plate	Comes with Steel Insulation Plate	Comes with Plastic Insulation Plate	Lip Bar or Term Bar
LENGTHS	1 5/8", 2 1/4", 3" – 8"	1 1/4", 1 3/4", 2" – 24" Call for lengths over 12"	1 3/4", 2" – 16"	1 5/8", 2 1/4", 3" – 8"	2 1/4", 3" – 8"	1", 1 1/4", 1 1/2", 2"
	Insulation Plate	Insulation Plate	Seam Plate	Barbed Seam Plate	Lip Bar	Flat Bar
						
SIZE	3" round flat	3" round ribbed	2" round	2" round	3/4" wide with 1/4" x 3/8" holes	1" wide with 1/4" x 3/8" holes
MATERIAL	Galvalume steel	Galvalume steel	Galvalume steel	Galvalume steel	Aluminum	Aluminum
SPACING	NA	NA	NA	NA	6" o.c.	6" o.c.

XHD® and ASAP® are registered trademarks of OMG, Inc. Copyright © 2016 OMG, Inc. All rights reserved.

100 PACKS Heavy Duty Fastener Masonry Anchor

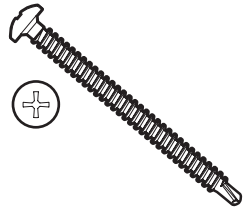
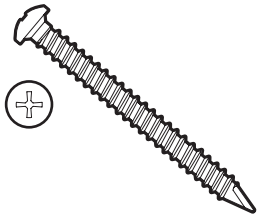
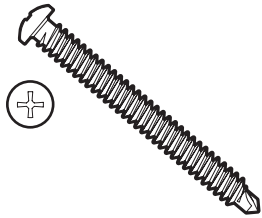
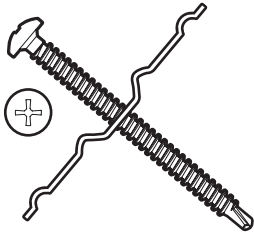
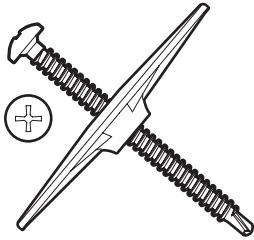
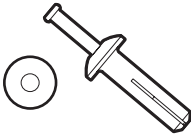
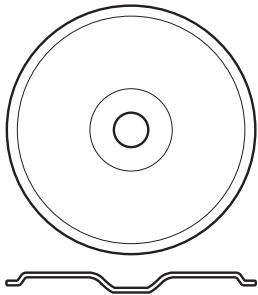
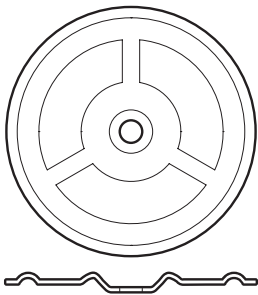
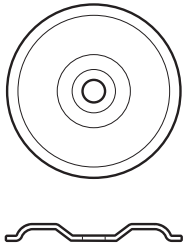
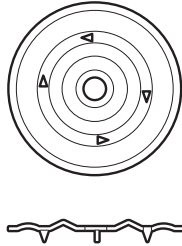
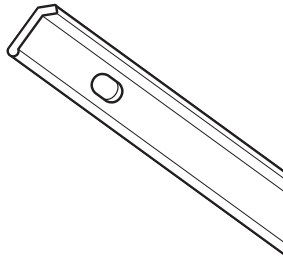
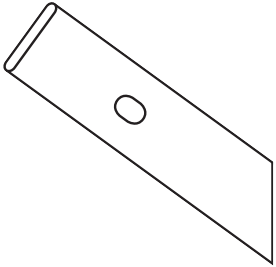
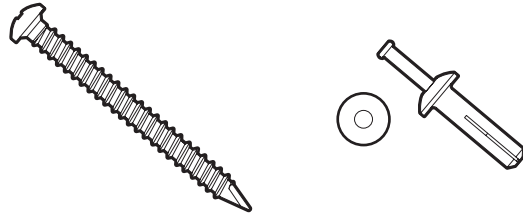

THREAD DIA./STYLE	#14 / AB symmetrical thread	Zinc alloy with zinc-plated steel pin
DECK TYPES	18 – 22 ga. steel, wood, concrete (3/16" pilot hole)	Concrete
FOR USE WITH	3" Insulation Plate, 2" Seam Plate	Lip Bar or Term Bar
LENGTHS	1 3/4", 2", 3", 4", 5", 6"	7/8", 1", 1 1/4", 1 1/2", 2"

Hercules Retro Drain

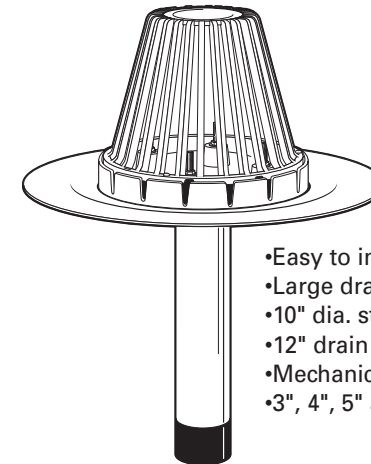

- Easy to install from rooftop
- Large drain flange
- 10" dia. strainer dome
- 12" drain stem
- Mechanical compression seal
- 3", 4", 5" and 6" sizes

100 PACKS Insulation Plate Seam Plate

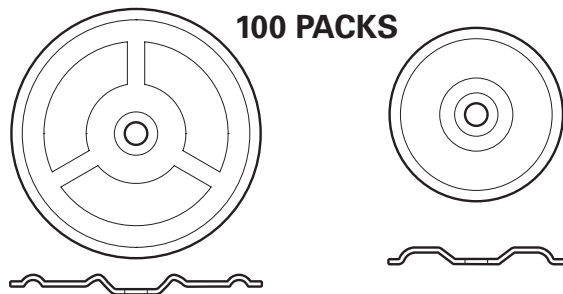

SIZE	3" round	2" round
MATERIAL	Galvalume steel	Galvalume steel
SPACING	NA	NA